

PS 3F-Lock

1.)

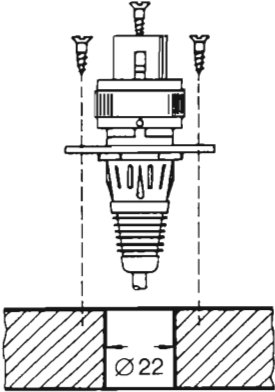

2.)

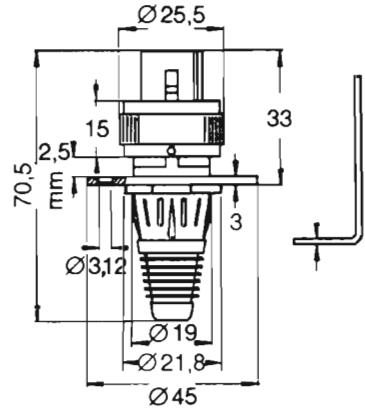

3.)

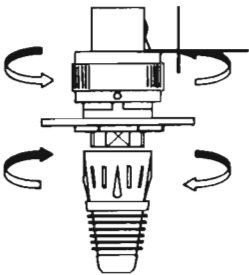

4.)

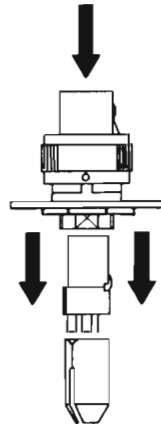

5.)

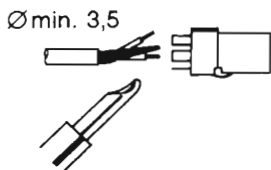

6.)

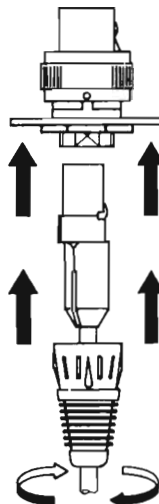

7.)

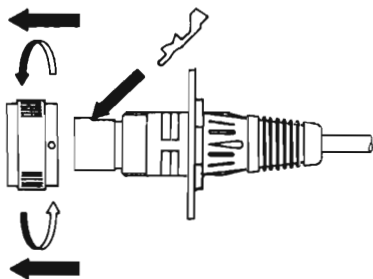

8.)

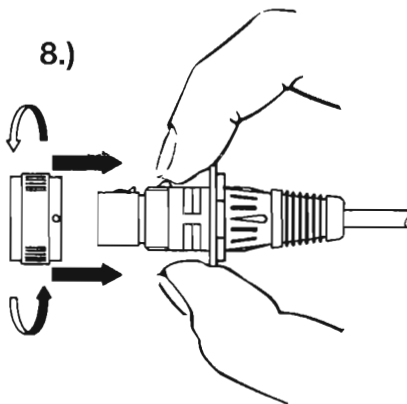

Mikrofone · Kopfhörer · Drahtmikrofone · Drahtloskopfhörer · Kopfsprechgerätee · Akustische Komponenten
Microphones · Headphones · Wireless Microphones · Wireless Headphones · Headsets · Electroacoustical Components

AKG Acoustics GmbH

Lemböckgasse 21-25, A-1230 Vienna/AUSTRIA, phone: (+43-1) 86654-0*
e-mail: sales@akg.com

AKG Acoustics, U.S.

8500 Balboa Boulevard, Northridge, CA 91329, U.S.A, phone: (+1 818) 920-3212
e-mail: akgsusa@harman.com

For other products and distributors worldwide visit www.akg.com



H A Harman International Company

*Technische Änderungen vorbehalten. Specifications subject to change without notice. Ces caractéristiques sont susceptibles de modifications.

© riserviamo il diritto di effettuare modifiche tecniche. Nos reservamos el derecho de introducir modificaciones técnicas. Especificações sujeitas a mudanças sem aviso prévio.

Printed in Austria on recycled paper.

05/07/9100 U 0758

